

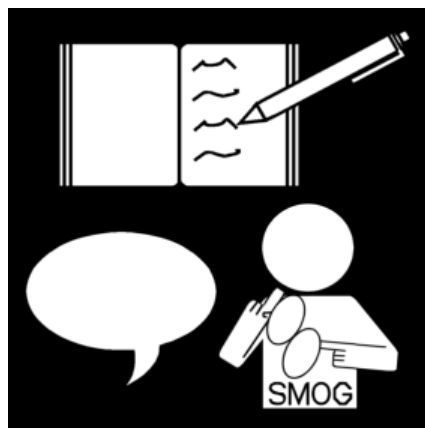





# WOORDENBOEK

## VOOR



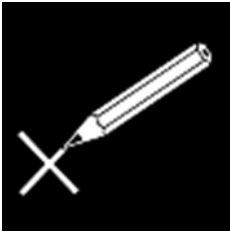

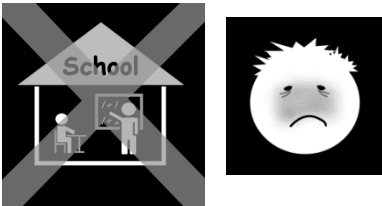
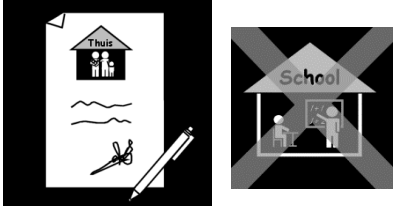
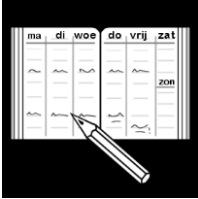
## OUDERS









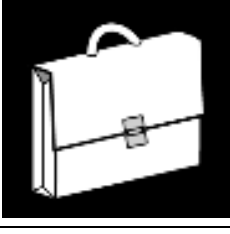
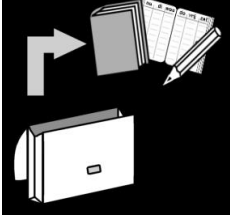



A

|  |  |  |
|--|--|--|
| <p><b>AANKRUISEN</b></p>                               |     |  |
| <p><b>AANWEZIG</b></p>                                 |     |  |
| <p><b>AFSPRAAK MAKEN</b></p>                           |     |  |
| <p><b>AFWEZIGHEID</b></p>                              |   |  |
| <p><b>AFWEZIG(HEID)<br/>AFWEZIGHEIDS<br/>BRIEF</b></p> |  |  |
| <p><b>AGENDA</b></p>                                   |   |  |
| <p><b>APRIL</b></p>                                    | <p><b>04/ (2016)</b></p>   |  |
| <p><b>AUGUSTUS</b></p>                                 | <p><b>08/ (2016)</b></p>   |  |
| <p><b>AUTO</b></p>                                     |   |  |

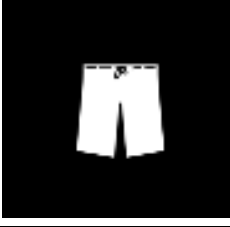

**B**

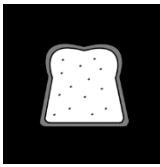
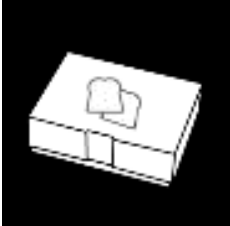
|                               |   |  |
|-------------------------------|---|--|
| <b>BEL</b>                    |    |  |
| <b>BELLEN<br/>TERUGBELLEN</b> |    |  |
| <b>BETALEN</b>                |    |  |
| <b>BIBLIOTHEEK</b>            |   |  |
| <b>BOEK(KEN)</b>              |  |  |
| <b>BOEKENTAS</b>              |  |  |
| <b>BOEKENTAS LEEGMAKEN</b>    |  |  |

|  |   |  |
|--|---|--|
| <p><b>BOERDERIJ</b></p> <p><b>BOERDERIJKLASSEN</b></p> |    |  |
| <p><b>Bos</b></p>                                      |    |  |
| <p><b>BOTERHAMMEN</b></p> <p><b>VERGETEN</b></p>       |    |  |
| <p><b>BRIEF</b></p>                                    |   |  |
| <p><b>BRIEF INVULLEN</b></p>                           |  |  |
| <p><b>BRIL</b></p>                                     |  |  |
| <p><b>BROEK</b></p>                                    |  |  |
| <p><b>BROEK NAT</b></p>                                |  |  |





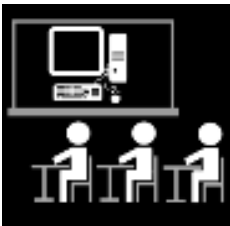

























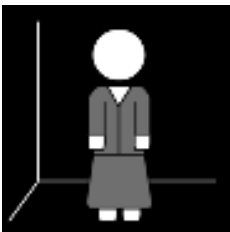
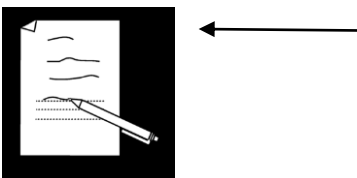
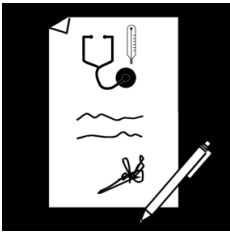











|                  |   |  |
|------------------|---|--|
| <b>BROOD</b>     |  |  |
| <b>BROODDOOS</b> |  |  |
| <b>BUS</b>       |  |  |

**C**

|                       |   |  |
|-----------------------|---|--|
| <b>CARNAVAL</b>       |  |  |
| <b>CASH</b>           |  |  |
| <b>COMPUTER (LES)</b> |  |  |



|              |   |  |
|--------------|---|--|
| CONTANT GELD |  |  |
|--------------|---|--|

**D**

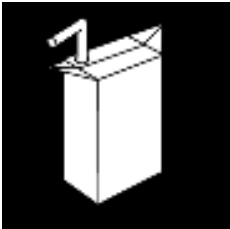
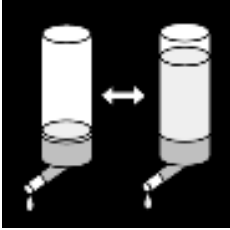



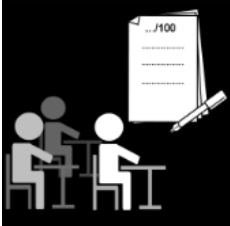

| DECEMBER  | 12/ (2016)   |   |   |  |   |   |  |         |         |          |           |         |          |        |   |   |   |   |  |   |   |  |  |  |  |  |  |  |
|---|--|---|---|--|---|---|--|---------|---------|----------|-----------|---------|----------|--------|---|---|---|---|--|---|---|--|--|--|--|--|--|--|
| DINSDAG   | <table border="1" style="width: 100%; text-align: center;"> <thead> <tr> <th style="font-size: small;">maandag</th> <th style="font-size: small;">dinsdag</th> <th style="font-size: small;">woensdag</th> <th style="font-size: small;">donderdag</th> <th style="font-size: small;">vrijdag</th> <th style="font-size: small;">zaterdag</th> <th style="font-size: small;">zondag</th> </tr> </thead> <tbody> <tr> <td></td> <td></td> <td></td> <td></td> <td></td> <td></td> <td></td> </tr> <tr> <td style="background-color: green;"></td> <td style="background-color: yellow;"></td> <td style="background-color: red; color: white;"></td> <td style="background-color: blue;"></td> <td style="background-color: orange;"></td> <td style="background-color: purple;"></td> <td style="background-color: brown;"></td> </tr> </tbody> </table>               |   |   |  |   |   |  | maandag | dinsdag | woensdag | donderdag | vrijdag | zaterdag | zondag |    |    |    |    |    |    |    |  |  |  |  |  |  |  |
| maandag   | dinsdag  | woensdag  | donderdag   | vrijdag  | zaterdag  | zondag  |  |         |         |          |           |         |          |        |   |   |   |   |  |   |   |  |  |  |  |  |  |  |
|    |   |    |    |    |    |    |  |         |         |          |           |         |          |        |   |   |   |   |  |   |   |  |  |  |  |  |  |  |
|   |  |   |   |  |   |   |  |         |         |          |           |         |          |        |   |   |   |   |  |   |   |  |  |  |  |  |  |  |
| DIRECTEUR   |   |   |   |  |   |   |  |         |         |          |           |         |          |        |   |   |   |   |  |   |   |  |  |  |  |  |  |  |
| DOCUMENT  |   |   |   |  |   |   |  |         |         |          |           |         |          |        |   |   |   |   |  |   |   |  |  |  |  |  |  |  |
| DOKTERSBRIEFJE  |   |   |   |  |   |   |  |         |         |          |           |         |          |        |   |   |   |   |  |   |   |  |  |  |  |  |  |  |
| DONDERDAG   | <table border="1" style="width: 100%; text-align: center;"> <thead> <tr> <th style="font-size: small;">maandag</th> <th style="font-size: small;">dinsdag</th> <th style="font-size: small;">woensdag</th> <th style="font-size: small;">donderdag</th> <th style="font-size: small;">vrijdag</th> <th style="font-size: small;">zaterdag</th> <th style="font-size: small;">zondag</th> </tr> </thead> <tbody> <tr> <td></td> <td></td> <td></td> <td></td> <td></td> <td></td> <td></td> </tr> <tr> <td style="background-color: green;"></td> <td style="background-color: yellow;"></td> <td style="background-color: red; color: white;"></td> <td style="background-color: blue;"></td> <td style="background-color: orange;"></td> <td style="background-color: purple;"></td> <td style="background-color: brown;"></td> </tr> </tbody> </table> |   |   |  |   |   |  | maandag | dinsdag | woensdag | donderdag | vrijdag | zaterdag | zondag |  |  |  |  |  |  |  |  |  |  |  |  |  |  |
| maandag   | dinsdag  | woensdag  | donderdag   | vrijdag  | zaterdag  | zondag  |  |         |         |          |           |         |          |        |   |   |   |   |  |   |   |  |  |  |  |  |  |  |
|  |   |  |  |  |  |  |  |         |         |          |           |         |          |        |   |   |   |   |  |   |   |  |  |  |  |  |  |  |
|   |  |   |   |  |   |   |  |         |         |          |           |         |          |        |   |   |   |   |  |   |   |  |  |  |  |  |  |  |

|                  |   |  |
|------------------|---|--|
| <b>DRANK(JE)</b> |  |  |
| <b>DRINKFLES</b> |  |  |

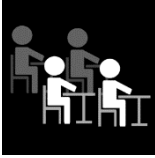

**E**

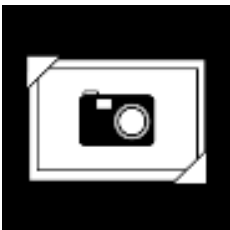
|                        |   |  |
|------------------------|---|--|
| <b>EINDE</b>           |   |  |
| <b>ETEN</b>            |  |  |
| <b>EXAMEN AFLEGGEN</b> |  |  |



F

|                                       |  |  |
|---------------------------------------|--|--|
| <p><b>FACTUUR</b></p>                 |                     |  |
| <p><b>FACULTATIEVE<br/>LESSEN</b></p> |  <p>15U15 – 16U</p> |  |
| <p><b>FEBRUARI</b></p>                | <p>02/ (2012)</p>  |  |
| <p><b>FEEST</b></p>                   |                     |  |
| <p><b>FIETS</b></p>                   |                    |  |
| <p><b>FLINK</b></p>                   |                   |  |
| <p><b>FOTO<br/>FOTOGRAAF</b></p>      |                   |  |
| <p><b>FOUTEN</b></p>                  |                   |  |





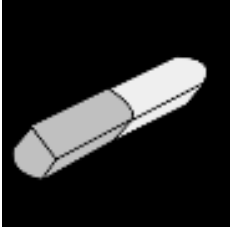
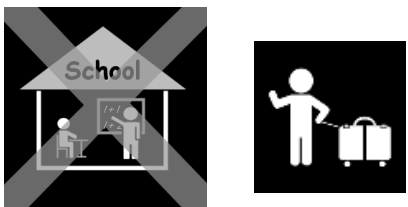

|                                       |   |  |
|---------------------------------------|---|--|
| FRANSE LES                            |  |  |
| FRISDRANK                             |  |  |
| FRUIT<br>(FRUITPROJECT)<br>(FRUITDAG) |  |  |

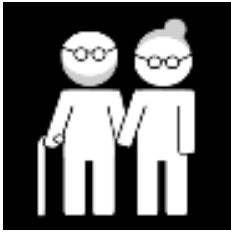

**G**

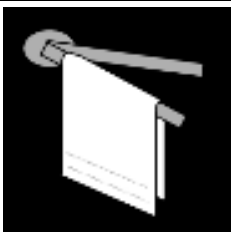
|                |  |  |
|----------------|--|--|
| GELD           |   |  |
| GEMEENTE       |   |  |
| GOM            |   |  |
| GROTE VAKANTIE |  |  |

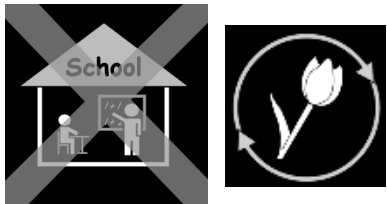
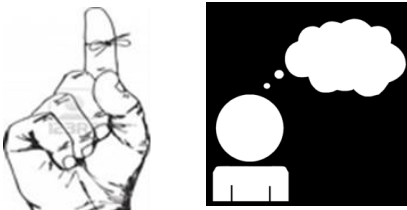

|             |   |  |
|-------------|---|--|
| GROOTOUDERS |  |  |
|-------------|---|--|

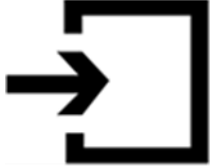
**H**

|                |  |  |
|----------------|--|--|
| HANDDOEK       |     |  |
| HANDSCHOENEN   |    |  |
| HANDTEKENING   |   |  |
| HERFST         |   |  |
| HERFSTVAKANTIE |  |  |
| HERINNERING    |  |  |

|                       |   |  |
|-----------------------|---|--|
| <b>HOOFDINGANG</b>    |  |  |
| <b>HUISWERK(KLAS)</b> |  |  |

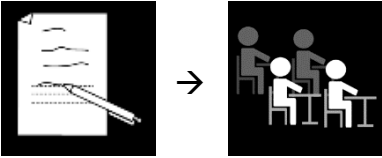

I

|                    |  |  |
|--------------------|--|--|
| <b>INFOMOMENT</b>  |    |  |
| <b>INSCHRIJVEN</b> |  |  |
| <b>INVULLEN</b>    |   |  |

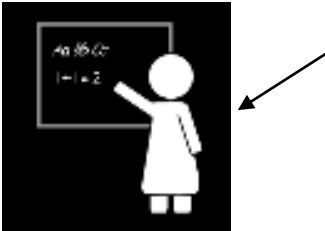
**J**



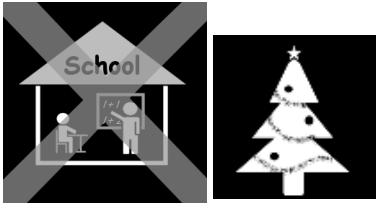

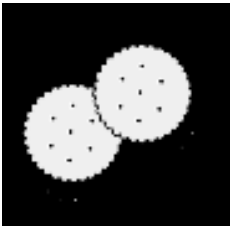
|                |  |  |
|----------------|--|--|
| <b>JAS</b>     |   |  |
| <b>JANUARI</b> | <b>01 / (2016)</b>   |  |
| <b>JUF</b>     |  |  |
| <b>JULI</b>    | <b>07 / (2016)</b>   |  |
| <b>JUNI</b>    | <b>06 / (2016)</b>   |  |

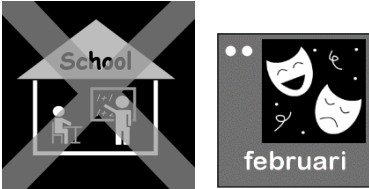



**K**

|                      |   |  |
|----------------------|---|--|
| <b>KERSTVAKANTIE</b> |  |  |
| <b>KLEUTERSCHOOL</b> | <b>2,5 JAAR – 5 JAAR</b>  |  |
| <b>KNIPPEN</b>       |  |  |
| <b>KOEK(JE)</b>      |  |  |

|                       |   |  |
|-----------------------|---|--|
| <b>KOUD</b>           |  |  |
| <b>KROKUSVAKANTIE</b> |  |  |













































**L**



|                      |   |  |
|----------------------|---|--|
| <b>LAARZEN</b>       |   |  |
| <b>LAGERE SCHOOL</b> | <b>6 JAAR – 12 JAAR</b>   |  |
| <b>LEERKRACHT</b>    |  |  |
| <b>LENTE</b>         |  |  |
| <b>LES</b>           |  |  |

|           |  |  |
|-----------|--|--|
| LEZEN     |   |  |
| LOPEN     |   |  |
| LUISTEREN |   |  |
| LUIZEN    |  |  |

**M**

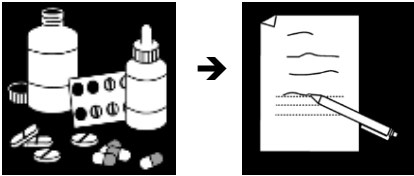
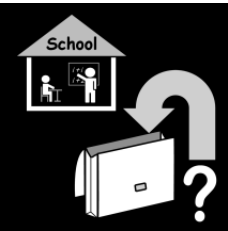
|            |  |  |
|------------|--|--|
| MAALTAFELS | $3 \times 9 =$ $8 \times 7 =$<br>$7 \times 6 =$ $9 \times 8 =$<br>$4 \times 8 =$ $8 \times 3 =$<br>$7 \times 4 =$ $3 \times 7 =$<br>$9 \times 6 =$ $6 \times 8 =$<br>$4 \times 9 =$ $7 \times 9 =$ |  |
| MAALTIJD   |   |  |
| MAAND      | <b>01 = JANUARI</b><br><b>02 = FEBRUARI</b><br><b>03 = MAART</b><br><b>04 = APRIL</b><br><b>05 = MEI</b>   |  |

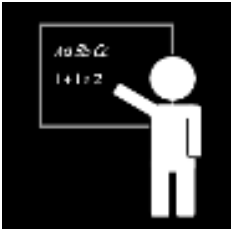
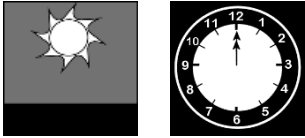
|   | <p>06 = JUNI<br/> 07 = JULI<br/> 08 = AUGUSTUS<br/> 09 = SEPTEMBER<br/> 10 = OKTOBER<br/> 11 = NOVEMBER<br/> 12 = DECEMBER</p>   |   |   |  |   |   |          |        |   |   |   |   |  |   |   |   |   |   |   |  |   |   |  |
|---|--|---|---|--|---|---|----------|--------|---|---|---|---|--|---|---|---|---|---|---|--|---|---|--|
| <b>MAANDAG</b>  | <table border="1"> <thead> <tr> <th>maandag</th> <th>dinsdag</th> <th>woensdag</th> <th>donderdag</th> <th>vrijdag</th> <th>zaterdag</th> <th>zondag</th> </tr> </thead> <tbody> <tr> <td></td> <td></td> <td></td> <td></td> <td></td> <td></td> <td></td> </tr> <tr> <td></td> <td></td> <td></td> <td></td> <td></td> <td></td> <td></td> </tr> </tbody> </table> | maandag   | dinsdag   | woensdag   | donderdag   | vrijdag   | zaterdag | zondag |  |  |  |  |  |  |  |  |  |  |  |  |  |  |  |
| maandag   | dinsdag  | woensdag  | donderdag   | vrijdag  | zaterdag  | zondag  |          |        |   |   |   |   |  |   |   |   |   |   |   |  |   |   |  |
|  |   |  |  |  |  |  |          |        |   |   |   |   |  |   |   |   |   |   |   |  |   |   |  |
|  |   |  |  |  |  |  |          |        |   |   |   |   |  |   |   |   |   |   |   |  |   |   |  |
| <b>MAART</b>  | <b>03/ (2016)</b>  |   |   |  |   |   |          |        |   |   |   |   |  |   |   |   |   |   |   |  |   |   |  |
| <b>MAMA</b>   |   |   |   |  |   |   |          |        |   |   |   |   |  |   |   |   |   |   |   |  |   |   |  |
| <b>MAP (RINGMAP)</b>  |    |   |   |  |   |   |          |        |   |   |   |   |  |   |   |   |   |   |   |  |   |   |  |
| <b>MEDICIJNEN,<br/>MEDICATIE</b>  |   |   |   |  |   |   |          |        |   |   |   |   |  |   |   |   |   |   |   |  |   |   |  |
| <b>MEDISCHE FICHE</b>   |    |   |   |  |   |   |          |        |   |   |   |   |  |   |   |   |   |   |   |  |   |   |  |
| <b>MEEBRENGEN</b>   |   |   |   |  |   |   |          |        |   |   |   |   |  |   |   |   |   |   |   |  |   |   |  |

|                    |   |  |
|--------------------|---|--|
| <b>MEESTER</b>     |  |  |
| <b>MEI</b>         | <b>05/ (2016)</b>   |  |
| <b>MIDDAG</b>      |  |  |
| <b>MOSSEL(LEN)</b> |   |  |
| <b>MUTS</b>        |  |  |





**N**

|                   |   |  |
|-------------------|---|--|
| <b>NAKIJKEN</b>   |  |  |
| <b>NEDERLANDS</b> |   |  |
| <b>NOVEMBER</b>   | <b>11/ (2016)</b>   |  |

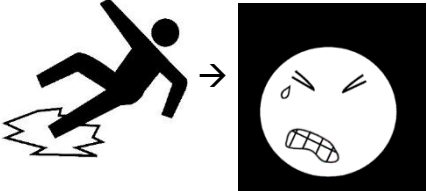

**O**





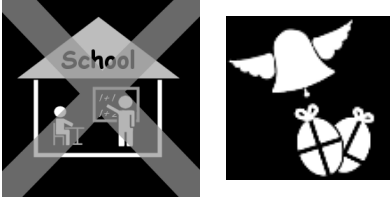

|                  |   |  |
|------------------|---|--|
| <b>OKTOBER</b>   | <b>10/ (2016)</b>   |  |
| <b>ONBELEefd</b> |  |  |

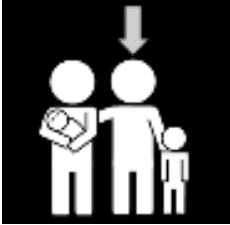

|                     |  |  |
|---------------------|--|--|
| <b>ONGEVAL(LEN)</b> |  |  |
| <b>ONTSMET</b>      |   |  |
| <b>OUDER(S)</b>     |   |  |
| <b>OUDERCONTACT</b> |  |  |

**P**

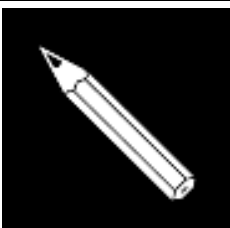
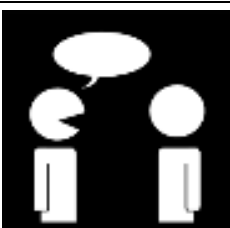
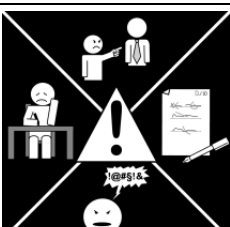



|                       |  |  |
|-----------------------|--|--|
| <b>PAASVAKANTIE</b>   |  |  |
| <b>PAMPER (LUIER)</b> |   |  |
| <b>PAPA</b>           |   |  |





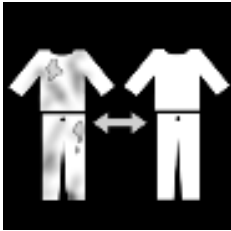

|                                   |   |  |
|-----------------------------------|---|--|
| <b>PEDAGOGISCHE<br/>STUDIEDAG</b> |    |  |
| <b>PEN</b>                        |    |  |
| <b>PIJN (BUIK)</b>                |    |  |
| <b>PIJN (HOOFD)</b>               |   |  |
| <b>POTLOOD</b>                    |  |  |
| <b>PRATEN</b>                     |  |  |
| <b>PROBLEEM</b>                   |  |  |
| <b>PRIJS<br/>PRIJZEN</b>          |  |  |



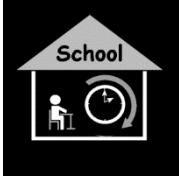

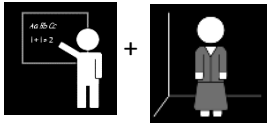

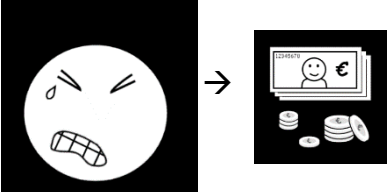
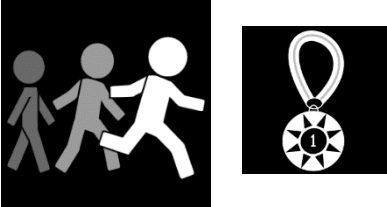
Q



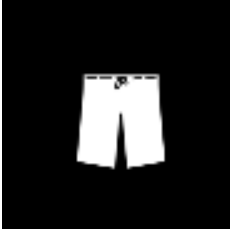

|  |  |  |
|--|--|--|
|  |  |  |
|--|--|--|

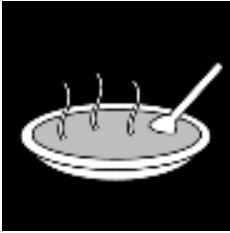
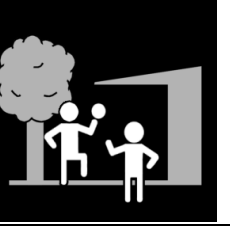
R

|                      |   |  |
|----------------------|---|--|
| <b>RAPPEL</b>        |                                  |  |
| <b>RAPPORT</b>       |  <p>85/100<br/>9/10<br/>....</p> |  |
| <b>REGENJAS</b>      |                                 |  |
| <b>RESERVEKLEDIJ</b> |                                |  |
| <b>RUGZAK</b>        |                                |  |





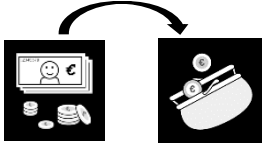

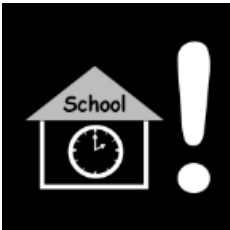

|                   |  |  |
|-------------------|--|--|
| SCHAATSEN         |   |  |
| SCHOOLDAG         |  <p data-bbox="839 555 986 622">8U30 –<br/>15U05</p>      |  |
| SCHOOLREIS        |   |  |
| SCHOOLTEAM        |    |  |
| SCHOOLUREN        |  <p data-bbox="863 1193 1002 1261">8U30 –<br/>15U05</p> |  |
| SCHOOLVERZEKERING |    |  |
| SCHOLENVELDLOOP   |    |  |
| SCHRIFT           |   |  |







|                       |   |  |
|-----------------------|---|--|
| SECRETARIAAT          |    |  |
| SEPTEMBER             | 09/ (2016)  |  |
| SHORT                 |    |  |
| SINTERKLAAS           |    |  |
| SJAAL                 |   |  |
| SNOEP                 |  |  |
| SOEP                  |  |  |
| SPEELPLAATS           |  |  |
| SPORT<br>SPORTKLASSEN |  |  |

|  |   |  |
|--|---|--|
| <b>START</b>                           |    |  |
| <b>STOUT</b>                           |    |  |
| <b>STRAF</b>                           |   |  |
| <b>STUDEREN</b>                        |   |  |
| <b>STUDIETOELAGE<br/>SCHOOLTOELAGE</b> |  |  |

**T**

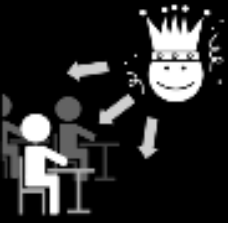

|                |   |  |
|----------------|---|--|
| <b>TAAL</b>    |  |  |
| <b>TE LAAT</b> |  |  |

|                         |  |  |
|-------------------------|--|--|
| <p><b>TEKENEN</b></p>   |   |  |
| <p><b>TELEFOON</b></p>  |   |  |
| <p><b>TE VOET</b></p>   |   |  |
| <p><b>TIJD</b></p>      |    |  |
| <p><b>TIJDIG</b></p>    |   |  |
| <p><b>TOETS(EN)</b></p> |   |  |
| <p><b>TOEZICHT</b></p>  |  <p><b>7U- 8U30</b><br/><b>15U05- 18u</b></p> |  |
| <p><b>TOILET</b></p>    |   |  |

|                          |   |  |
|--------------------------|---|--|
| <b>TOLK</b>              |    |  |
| <b>TONEEL</b>            |    |  |
| <b>TRAKTEREN</b>         |    |  |
| <b>T-SHIRT</b>           |   |  |
| <b>TURNEN</b>            |  |  |
| <b>TURN-PANTOFFEL(S)</b> |  |  |











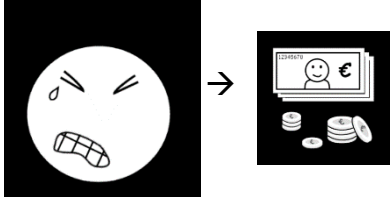

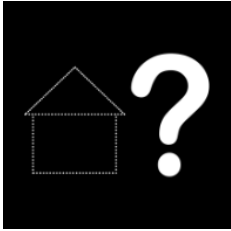



































U

|   |   |  |
|---|---|--|
| <p><b>UITNODIGEN,<br/>UITNODIGING</b></p> |  |  |
| <p><b>UITSTAP</b></p>                     |  |  |
| <p><b>UUR</b></p>                         |  |  |

V

|                          |  |  |
|--------------------------|--|--|
| <p><b>VAKANTIE</b></p>   |  |  |
| <p><b>VALLEN</b></p>     |   |  |
| <p><b>VERJAARDAG</b></p> |   |  |

| <b>VERLOREN (VOORWERP)</b>  |    |   |   |  |   |   |          |        |   |   |   |   |  |   |   |   |   |   |   |  |   |   |
|---|---|---|---|--|---|---|----------|--------|---|---|---|---|--|---|---|---|---|---|---|--|---|---|
| <b>VERZEKERING</b>  |   |   |   |  |   |   |          |        |   |   |   |   |  |   |   |   |   |   |   |  |   |   |
| <b>VERZORGING</b>   |    |   |   |  |   |   |          |        |   |   |   |   |  |   |   |   |   |   |   |  |   |   |
| <b>VOCHTIGE DOEKJES</b>   |   |   |   |  |   |   |          |        |   |   |   |   |  |   |   |   |   |   |   |  |   |   |
| <b>VRAAG, VRAGEN</b>  |    |   |   |  |   |   |          |        |   |   |   |   |  |   |   |   |   |   |   |  |   |   |
| <b>VRIENDEN, VRIENDINNEN</b>  |    |   |   |  |   |   |          |        |   |   |   |   |  |   |   |   |   |   |   |  |   |   |
| <b>VRIJDAG</b>  | <table border="1" data-bbox="616 1599 1310 1834"> <thead> <tr> <th>maandag</th> <th>dinsdag</th> <th>woensdag</th> <th>donderdag</th> <th>vrijdag</th> <th>zaterdag</th> <th>zondag</th> </tr> </thead> <tbody> <tr> <td></td> <td></td> <td></td> <td></td> <td></td> <td></td> <td></td> </tr> <tr> <td></td> <td></td> <td></td> <td></td> <td></td> <td></td> <td></td> </tr> </tbody> </table> | maandag   | dinsdag   | woensdag   | donderdag   | vrijdag   | zaterdag | zondag |  |  |  |  |  |  |  |  |  |  |  |  |  |  |
| maandag   | dinsdag   | woensdag  | donderdag   | vrijdag  | zaterdag  | zondag  |          |        |   |   |   |   |  |   |   |   |   |   |   |  |   |   |
|  |    |  |  |  |  |  |          |        |   |   |   |   |  |   |   |   |   |   |   |  |   |   |
|  |    |  |  |  |  |  |          |        |   |   |   |   |  |   |   |   |   |   |   |  |   |   |
| <b>VRIJE DAG</b>  |    |   |   |  |   |   |          |        |   |   |   |   |  |   |   |   |   |   |   |  |   |   |

**VULPEN**



**W**

**WANDELEN**



**WANNEER**

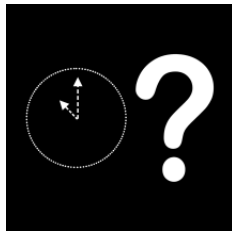

**WARM**









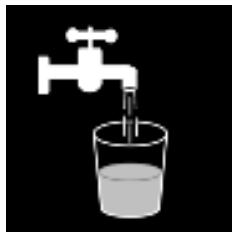







**WARME MAALTIJD**

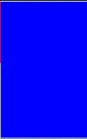

**WATER**



|                 |   |   |  |   |   |  |  |                   |
|-----------------|---|---|--|---|---|--|--|-------------------|
| <b>WINTER</b>   |    |   |  |   |   |  |  |                   |
| <b>WOENSDAG</b> | maandag<br><br> | dinsdag<br><br> | woensdag<br><br> | donderdag<br><br> | vrijdag<br><br> | zaterdag<br><br> | zondag<br><br> | <b>8u30 – 12u</b> |



**X**

















































|  |  |  |
|--|--|--|
|  |  |  |
|--|--|--|



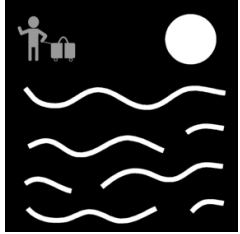







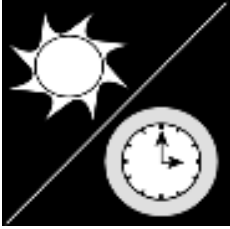

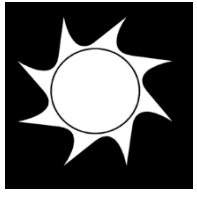



































**Y**

|  |  |  |
|--|--|--|
|  |  |  |
|--|--|--|

**Z**

|                     |   |  |
|---------------------|---|--|
| <b>ZAK</b>          |  |  |
| <b>ZAKDOEK(KEN)</b> |  |  |

| <b>ZATERDAG</b>   | <table border="1"> <thead> <tr> <th data-bbox="614 145 699 174">maandag</th> <th data-bbox="703 145 788 174">dinsdag</th> <th data-bbox="793 145 877 174">woensdag</th> <th data-bbox="882 145 967 174">donderdag</th> <th data-bbox="971 145 1056 174">vrijdag</th> <th data-bbox="1061 145 1145 174">zaterdag</th> <th data-bbox="1150 145 1235 174">zondag</th> </tr> </thead> <tbody> <tr> <td data-bbox="614 174 699 241"></td> <td data-bbox="703 174 788 241"></td> <td data-bbox="793 174 877 241"></td> <td data-bbox="882 174 967 241"></td> <td data-bbox="971 174 1056 241"></td> <td data-bbox="1061 174 1145 241"></td> <td data-bbox="1150 174 1235 241"></td> </tr> <tr> <td data-bbox="614 241 699 398"></td> <td data-bbox="703 241 788 398"></td> <td data-bbox="793 241 877 398"></td> <td data-bbox="882 241 967 398"></td> <td data-bbox="971 241 1056 398"></td> <td data-bbox="1061 241 1145 398"></td> <td data-bbox="1150 241 1235 398"></td> </tr> </tbody> </table> |   |   |  |   |   |  | maandag | dinsdag | woensdag | donderdag | vrijdag | zaterdag | zondag |  |  |  |  |  |  |  |  |  |  |  |  |  |  |
|---|---|---|---|--|---|---|--|---------|---------|----------|-----------|---------|----------|--------|---|---|---|---|--|---|---|---|---|---|---|--|---|---|
| maandag   | dinsdag   | woensdag  | donderdag   | vrijdag  | zaterdag  | zondag  |  |         |         |          |           |         |          |        |   |   |   |   |  |   |   |   |   |   |   |  |   |   |
|  |    |  |  |  |  |  |  |         |         |          |           |         |          |        |   |   |   |   |  |   |   |   |   |   |   |  |   |   |
|  |    |  |  |  |  |  |  |         |         |          |           |         |          |        |   |   |   |   |  |   |   |   |   |   |   |  |   |   |
| <b>ZEE</b><br><br><b>ZEEKLASSEN</b>   |    |   |   |  |   |   |  |         |         |          |           |         |          |        |   |   |   |   |  |   |   |   |   |   |   |  |   |   |
| <b>ZIEK</b><br><br><b>ZIEKTE</b><br><b>ZIEKTES</b>                                |    |   |   |  |   |   |  |         |         |          |           |         |          |        |   |   |   |   |  |   |   |   |   |   |   |  |   |   |
| <b>ZIEKENWAGEN</b>  |   |   |   |  |   |   |  |         |         |          |           |         |          |        |   |   |   |   |  |   |   |   |   |   |   |  |   |   |
| <b>ZIEKTEBRIEF(JE)</b>  |    |   |   |  |   |   |  |         |         |          |           |         |          |        |   |   |   |   |  |   |   |   |   |   |   |  |   |   |
| <b>ZINDELIJK</b>  |    |   |   |  |   |   |  |         |         |          |           |         |          |        |   |   |   |   |  |   |   |   |   |   |   |  |   |   |
| <b>ZOMER</b>  |    |   |   |  |   |   |  |         |         |          |           |         |          |        |   |   |   |   |  |   |   |   |   |   |   |  |   |   |

| <b>ZOMERUUR</b>   |   |   |   |  |   |   |          |        |   |   |   |   |  |   |   |   |   |   |   |  |   |   |
|---|--|---|---|--|---|---|----------|--------|---|---|---|---|--|---|---|---|---|---|---|--|---|---|
| <b>ZOMERVAKANTIE</b>  |      |   |   |  |   |   |          |        |   |   |   |   |  |   |   |   |   |   |   |  |   |   |
| <b>ZONDAG</b>   | <table border="1" data-bbox="612 629 1302 860"> <thead> <tr> <th data-bbox="612 629 695 651">maandag</th> <th data-bbox="695 629 778 651">dinsdag</th> <th data-bbox="778 629 861 651">woensdag</th> <th data-bbox="861 629 944 651">donderdag</th> <th data-bbox="944 629 1027 651">vrijdag</th> <th data-bbox="1027 629 1110 651">zaterdag</th> <th data-bbox="1110 629 1193 651">zondag</th> </tr> </thead> <tbody> <tr> <td data-bbox="612 651 695 719"></td> <td data-bbox="695 651 778 719"></td> <td data-bbox="778 651 861 719"></td> <td data-bbox="861 651 944 719"></td> <td data-bbox="944 651 1027 719"></td> <td data-bbox="1027 651 1110 719"></td> <td data-bbox="1110 651 1193 719"></td> </tr> <tr> <td data-bbox="612 719 695 860"></td> <td data-bbox="695 719 778 860"></td> <td data-bbox="778 719 861 860"></td> <td data-bbox="861 719 944 860"></td> <td data-bbox="944 719 1027 860"></td> <td data-bbox="1027 719 1110 860"></td> <td data-bbox="1110 719 1193 860"></td> </tr> </tbody> </table> | maandag   | dinsdag   | woensdag   | donderdag   | vrijdag   | zaterdag | zondag |  |  |  |  |  |  |  |  |  |  |  |  |  |  |
| maandag   | dinsdag  | woensdag  | donderdag   | vrijdag  | zaterdag  | zondag  |          |        |   |   |   |   |  |   |   |   |   |   |   |  |   |   |
|  |   |  |  |  |  |  |          |        |   |   |   |   |  |   |   |   |   |   |   |  |   |   |
|  |   |  |  |  |  |  |          |        |   |   |   |   |  |   |   |   |   |   |   |  |   |   |
| <b>ZWEMBROEK</b>  |    |   |   |  |   |   |          |        |   |   |   |   |  |   |   |   |   |   |   |  |   |   |
| <b>ZWEMMEN</b>  |   |   |   |  |   |   |          |        |   |   |   |   |  |   |   |   |   |   |   |  |   |   |
| <b>ZWEMPAK</b>  |   |   |   |  |   |   |          |        |   |   |   |   |  |   |   |   |   |   |   |  |   |   |